

Intara XR

Article number: 50720014

LIGHT TECHNOLOGY

LED	COB
Light colour	835
Luminous flux	2110 lm
System power	17 W
Luminaire Efficiency	124 lm/W
Reflector	Flood
Beam angle	44°
Controller	On/Off

LUMINAIRE

Rotation angle	400°
Swivel angle	+/- 85°
Weight	0.65 kg
Protection rating . class	IP 20 . II
Luminaire colour	silver

OPTIONAL

RAL-colours, NCS-colours (powder coating or wet spraying) on inquiry, surface alloys on inquiry, honeycomb louver

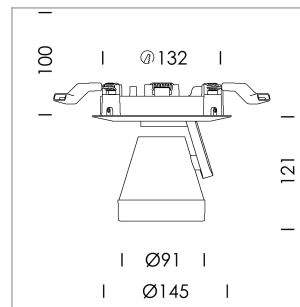

Semi-recessed luminaire with LED, rated life of the LED L80/B10 50000 h (tambient 25°C), colour rendering index CRI > 80, chromaticity tolerance 2 SDCM (initial), reflector with circular light distribution pattern, reflector pure aluminium 99,99% in MIRO-Silver®, segmented and faceted, die-cast aluminium, powder-coated, rotation angle 400°, swivel angle +/- 85°, silver, separate driver unit

76500050 driver unit, On/Off, 220-240 V / 50-60 Hz, 400 mA, camera-compatible, up to 2.5 KV interference resistance, SELV, max. 34 luminaires per circuit (B16A fuse)

76500051 driver unit, DALI, 220-240 V / 50-60 Hz, 400 mA, with GST18/5-pin connector, incl. 5-conductor feed-through wiring, camera-compatible, up to 2.5 KV interference resistance, SELV, max. 24 luminaires per circuit (B16A fuse)

Note: All data are typical values. System features may change with product improvements due to technical advances. Errors excepted.

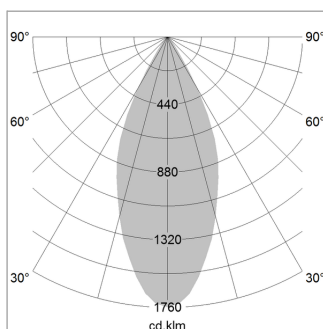

1.0 m	0.81	3712.8
2.0 m	1.62	928.2
3.0 m	2.43	412.5
4.0 m	3.24	232.0
5.0 m	4.05	148.5
	Ø (m)	E0(0°) [lx]

