

Ontero IC

Article number: 21500144

LIGHT TECHNOLOGY

LED	COB
Light colour	BeNature
Luminous flux	1620 lm
System power	41 W
Luminaire Efficiency	40 lm/W
Reflector	Spot
Beam angle	20°
Controller	On/Off

LUMINAIRE

Rotation angle	330°
Swivel angle	+/- 90°
Weight	1.1 kg
Protection rating . class	IP 20 . II
Luminaire colour	white

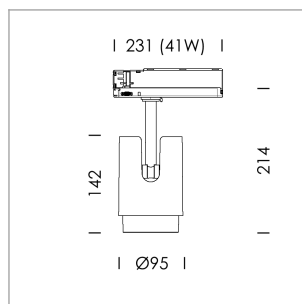

Surface-mounted luminaire with LED, rated life of the LED L80/B10 50000 h (tambient 25°C), colour rendering index CRI > 95, chromaticity tolerance 2 SDCM (initial), 3D silicone lens to reduce the proportion of scattered light, rotation-symmetrical reflector with circular light distribution pattern, primary reflector and kick reflector 99% pure aluminium in MIRO-Silver®, luminaire head/retention arm die-cast aluminium, powder-coated, white, rotation angle 330°, swivel angle +/- 90°, In-Track-Adapter, On/Off, 220-240 V~ / 50-60 Hz, max. 64 luminaires per circuit (B16A fuse)

Note: All data are typical values. System features may change with product improvements due to technical advances. Errors excepted.

