

Intara IC

Article number: 51520031

LIGHT TECHNOLOGY

LED	COB
Light colour	Meat&Fish
Luminous flux	1570 lm
System power	23 W
Luminaire Efficiency	68 lm/W
Reflector	Spot
Beam angle	20°
Controller	On/Off

LUMINAIRE

Rotation angle	330°
Swivel angle	+/- 90°
Weight	1.2 kg
Protection rating . class	IP 20 . III
Luminaire colour	white

OPCJA

RAL-colours, NCS-colours (powder coating or wet spraying) on inquiry, surface alloys on inquiry, honeycomb louver

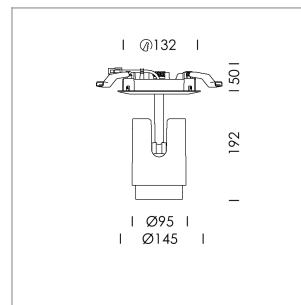

Semi-recessed luminaire with LED, rated life of the LED L80/B10 50000 h (ambient 25°C), colour rendering index CRI > 70, chromaticity tolerance 2 SDCM (initial), 3D silicone lens to reduce the proportion of scattered light, rotation-symmetrical reflector with circular light distribution pattern, reflector pure aluminium 99,99% in MIRO-Silver®, segmented and faceted, exchangeable reflector unit in high-shine black plastic, with glass cover, rotation angle 330°, swivel angle +/- 90°, luminaire housing die-cast aluminium, powder-coated, white, separate driver unit

76500034 driver unit, On/Off, 220-240 V / 50-60 Hz, 600 mA, camera-compatible, up to 2.5 KV interference resistance, SELV, max. 34 luminaires per circuit (B16A fuse)

76500039 driver unit, DALI, 220-240 V / 50-60 Hz, 600 mA, with GST18/5-pin connector, incl. 5-conductor feed-through wiring, camera-compatible, up to 2.5 KV interference resistance, SELV, max. 24 luminaires per circuit (B16A fuse)

76500122 driver unit, Casambi, 220-240 V / 50-60 Hz, 600 mA, camera-compatible, up to 2.5 KV interference resistance, SELV, max. 23 luminaires per circuit (B16A fuse)

Note: All data are typical values. System features may change with product improvements due to technical advances. Errors excepted.

