

Intara SQ 174

Article number: 50660003

LIGHT TECHNOLOGY

LED	COB
Light colour	840
Luminous flux	4500 lm
System power	41 W
Luminaire Efficiency	110 lm/W
Reflector	Spot
Beam angle	16°
Controller	On/Off

LUMINAIRE

Swivel angle	+/- 30°
Weight	1.1 kg
Protection rating . class	IP 20 . III
Luminaire colour	black

OPCJA

RAL-colours, NCS-colours (powder coating or wet spraying) on inquiry, surface alloys on inquiry, honeycomb louver

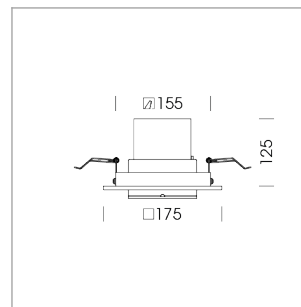

Recessed luminaire with LED, rated life of the LED L80/B10 > 50000 h, colour rendering index CRI > 80, chromaticity tolerance 2 SDCM (initial), reflector with circular light distribution pattern, reflector pure aluminium 99,99% in MIRO-Silver®, cardanic, swivel angle +/-30°, luminaire housing sheet steel, powder-coated, black, separate driver unit

76500037 driver unit, On/Off, 220-240 V / 50-60 Hz, 1050 mA, camera-compatible, up to 2.5 KV interference resistance, SELV, max. 22 luminaires per circuit (B16A fuse)

76500042 driver unit, DALI, 220-240 V / 50-60 Hz, 1050 mA, with GST18/5-pin connector, incl. 5-conductor feed-through wiring, camera-compatible, up to 2.5 KV interference resistance, SELV, max. 22 luminaires per circuit (B16A fuse)

Note: All data are typical values. System features may change with product improvements due to technical advances. Errors excepted.

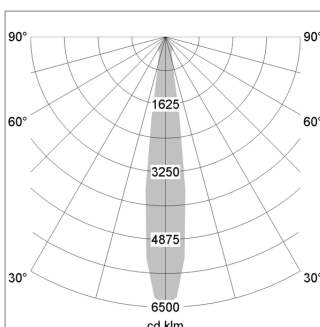

1.0 m	0.29	29222.2
2.0 m	0.58	7305.5
3.0 m	0.87	3246.9
4.0 m	1.16	1826.4
5.0 m	1.45	1168.9
Ø (m)		E0(0°) [lx]

